

# C65 Microturbine

High-pressure Natural Gas, ICHP



**Achieve ultra-low emissions and reliable electrical/thermal generation from natural gas.**

- + Ultra-low emissions
- + One moving part – minimal maintenance and downtime
- + Patented air bearings – no lubricating oil or coolant
- + Integrated utility synchronization – no external switchgear
- + Compact modular design allows for easy, low-cost installation
- + Multiple units easily combined – act as single generating source
- + Remote monitoring and diagnostic capabilities
- + Proven technology with tens of millions of operating hours
- + Various Factory Protection Plans available



C65 ICHP Microturbine

## Electrical Performance<sup>(1)</sup>

Electrical Power Output	65kW
Voltage	400/480 VAC
Electrical Service	3-Phase, 4 Wire Wye
Frequency	50/60 Hz
Electrical Efficiency LHV	29%

## Fuel/Engine Characteristics<sup>(1)</sup>

Natural Gas HHV	30.7–47.5 MJ/m <sup>3</sup> (825–1,275 BTU/scf)
Inlet Pressure	517–551 kPa gauge (75–80 psig)
Fuel Flow HHV	888 MJ/hr (842,000 BTU/hr)
Net Heat Rate LHV	12.4 MJ/kWh (11,800 BTU/kWh)

## Exhaust Characteristics<sup>(1)</sup>

NO <sub>x</sub> Emissions @ 15% O <sub>2</sub>	< 9 ppmvd (19 mg/m <sup>3</sup> )
Exhaust Mass Flow	0.49 kg/s (1.08 lbm/s)
Exhaust Gas Temperature	309°C (588°F) (Heat Recovery Bypassed)

## ICHP Heat Recovery<sup>(2)</sup>

Integrated Heat Recovery Module Type	Copper Core	Stainless Steel Core
Hot Water Heat Recovery	122kW (0.42 MMBTU/hr)	70kW (0.24 MMBTU/hr)

*Reliable power when and where you need it. Clean and simple.*

## Dimensions & Weight<sup>(3)</sup>

Width x Depth x Height <sup>(4)</sup>	0.76 x 2.20 x 2.36 m (30 x 87 x 93 in)
Weight - Grid Connect Model	998 kg (2,200 lb)
Weight - Dual Mode Model	1,364 kg (3,000 lb)

## Minimum Clearance Requirements<sup>(5)</sup>

Horizontal Clearance	
Left & Right	0.76 m (30 in)
Front - Grid Connect Model	0.76 m (30 in)
Front - Dual Mode Model	1.65 m (65 in)
Rear	0.76 m (30 in)

## Acoustic Emissions

Nominal at Full Power at 10 m (33 ft)	65 dBA
---------------------------------------	--------

## Certifications

- UL 2200 Listed
- CE Certified
- Certified to the following grid interconnection standards: UL 1741, VDE, and BDEW
- Compliant to California Rule 21

## C65 Engine Components

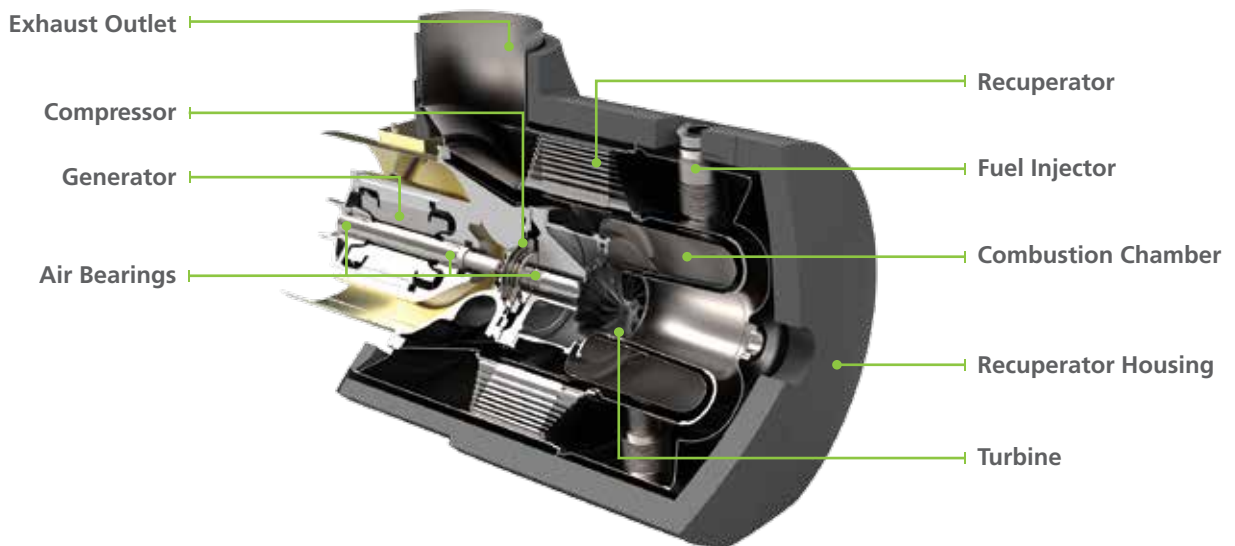

(1) Nominal full power performance at ISO conditions: 15°C (59°F), 14.696 psia, 60% RH  
 (2) Heat recovery for water inlet temperature of 60°C (140°F) and flow rate of 2.5 l/s (40 GPM)  
 (3) Approximate dimensions and weights  
 (4) Height dimensions are to the roofline. Exhaust stack extends at least 178 mm (7 in) above the roofline  
 (5) Clearance requirements may increase due to local code considerations  
 Specifications are not warranted and are subject to change without notice.

